

**Standby Power Rating**  
 15 kW, 19 kVA, 60 Hz



\*Assembled in the USA using domestic and foreign parts

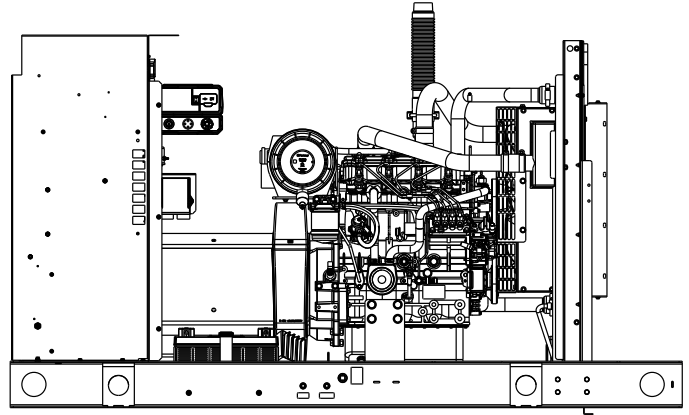

Image used for illustration purposes only

## Codes and Standards

**Not all codes and standards apply to all configurations. Contact factory for details.**



UL2200, UL6200, UL1236, UL489



CSA C22.2, ULC S601



BS5514 and DIN 6271



SAE J1349



NFPA 37, 70, 99, 110



NEC700, 701, 702, 708



NEMA ICS10, MG1, 250, ICS6, AB1



ANSI C62.41

## Powering Ahead

For over 60 years, Generac has provided innovative design and superior manufacturing.

Generac ensures superior quality by designing and manufacturing most of its generator components, including alternators, enclosures and base tanks, control systems and communications software.

Generac gensets utilize a wide variety of options, configurations and arrangements, allowing us to meet the standby power needs of practically every application.

Generac searched globally to ensure the most reliable engines power our generators. We choose only engines that have already been proven in heavy-duty industrial applications under adverse conditions.

Generac is committed to ensuring our customers' service support continues after their generator purchase.

# SD015T | 2.2L | 15 kW

## INDUSTRIAL DIESEL GENERATOR SET

EPA Certified Stationary Emergency

### STANDARD FEATURES

#### ENGINE SYSTEM

- Oil Drain System
- Air Filter Restriction Indicator
- Air Cleaner
- Level 1 Fan and Belt Guards (Open Set Only)
- Stainless Steel Flexible Exhaust Connection
- Factory Filled Oil and Coolant
- Radiator Duct Adapter (Open Set Only)
- Critical Silencer (Enclosed Units Only)
- Engine Coolant Heater

#### FUEL SYSTEM

- Fuel Lockoff Solenoid
- Primary Fuel Filter

#### COOLING SYSTEM

- Closed Coolant Recovery System
- UV/Ozone Resistant Hoses
- Factory-Installed Radiator
- 50/50 Ethylene Glycol Antifreeze
- Radiator Drain Extension

#### ELECTRICAL SYSTEM

- Battery Charging Alternator
- Battery Cables
- Battery Tray
- Rubber-Booted Engine Electrical Connections
- Solenoid Activated Starter Motor

#### ALTERNATOR SYSTEM

- UL2200 GENprotect™
- Class H Insulation Material
- 2/3 Pitch
- Skewed Stator
- Brushless Excitation
- Sealed Bearings
- Rotor Dynamically Spin Balanced
- Amortisseur Winding (3-Phase Only)
- Full Load Capacity Alternator
- Protective Thermal Switch

#### GENERATOR SET

- Internal Genset Vibration Isolation
- Separation of Circuits - High/Low Voltage
- Separation of Circuits - Multiple Breakers
- Wrapped Exhaust Piping (Enclosed Units Only)
- Standard Factory Testing
- 2 Year Limited Warranty (Standby Rated Units)
- Silencer Mounted in the Discharge Hood (Enclosed Units Only)

#### ENCLOSURE (IF SELECTED)

- Rust-Proof Fasteners with Nylon Washers to Protect Finish
- High Performance Sound-Absorbing Material (Sound Attenuated Enclosures)
- Gasketed Doors
- Upward Facing Discharge Hoods (Radiator and Exhaust)
- RhinoCoat™ - Textured Polyester Powder Coat Paint

#### FUEL TANKS (IF SELECTED)

- UL 142/ULC S601
- Double Wall
- Normal and Emergency Vents
- Factory Pressure Tested
- Rupture Basin Alarm
- Fuel Level
- Check Valve In Supply and Return Lines
- RhinoCoat™ - Textured Polyester Powder Coat Paint
- Stainless Steel Hardware

#### CONTROL SYSTEM

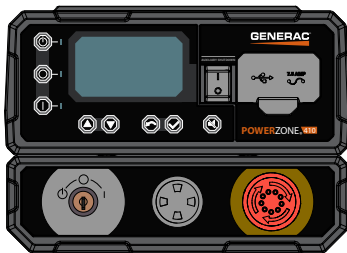

#### Power Zone® 410 Controller

##### Features

- Programmable Auto Crank
- Selectable Low Speed Exercise
- RS-232 x2
- RS-485 x2
- All-Phase Sensing Digital Voltage Regulator
- On/Off/Manual Switch

- Not in Auto (Flashing Light)
- Emergency Stop
- Modbus® RTU
- CANbus
- Full Range Standby Operation
- Power Factor
- Ruptured Tank Detection
- Auxiliary Shutdown Switch
- Remote Communications
- NFPA110 Module Included (Key Switch, Alarm, EStop)
- I²T Function for Full Generator Protection (Contact Factory)

##### Full System Status Display

- Full System Status Display
- Multilingual 128x64 Graphical Display with Heater
- Easy Status View LED Screen
- 3-Phase AC Volts
- 3-Phase Amps
- kW

- Line Power/Gen Power
- Time
- Date
- Run Hours
- Service Reminders
- Fault History (Alarm Log)
- Oil Pressure
- Oil Temperature Indication and Alarm
- Output for Fuel Level High/Low Warning
- Water Temperature
- Water Level
- Fuel Pressure/Level
- Engine Speed
- Battery Voltage
- Alternator Frequency

##### Alarms and Warnings

- Common Alarm Output
- Audible Alarm and Silence

## CONFIGURABLE OPTIONS

### ENGINE SYSTEM

- Oil Heater
- Critical Silencer (Open Set Only)
- Radiator Stone Guard
- Level 1 Fan and Belt Guards (Enclosed Units Only)
- Two Stage Air Filter

### FUEL SYSTEM

- NPT Flexible Fuel Line

### ELECTRICAL SYSTEM

- 10A UL Listed Battery Charger
- Battery Warmer

### ALTERNATOR SYSTEM

- Anti-Condensation Heater
- Tropical Coating
- Permanent Magnet Excitation

### GENERATOR SET

- Extended Factory Testing (3-Phase Only)
- 8 Position Load Center
- Pad Vibration Isolation
- Spring Vibration Isolators

### CIRCUIT BREAKER OPTIONS

- Main Line Circuit Breaker
- 2nd Main Line Circuit Breaker
- 3rd Main Line Circuit Breaker
- Shunt Trip and Auxiliary Contact
- Electronic Trip Breakers

### ENCLOSURE

- Level 0 Sound Attenuated
- Level 1 Sound Attenuated
- Level 2 Sound Attenuated
- Steel Enclosure
- Aluminum Enclosure
- Up to 200 MPH Wind Load Rating (Contact Factory for Availability)
- AC/DC Enclosure Lighting Kit
- Door Open Alarm Switch

### WARRANTY (STANDBY GENSETS ONLY)

- 2 Year Extended Limited Warranty
- 5 Year Limited Warranty
- 5 Year Extended Limited Warranty
- 7 Year Extended Limited Warranty
- 10 Year Extended Limited Warranty

### CONTROL SYSTEM

- NFPA Module
- NFPA 110 Compliant 21-Light Remote Annunciator
- Remote Relay Assembly (8 or 16)
- Oil Temperature Indicator and Alarm
- Inputs (x12) / Outputs (x12)
- Battery Disconnect Switch
- Remote E-Stop (Break Glass-Type, Surface Mount)
- Remote E-Stop (Red Mushroom-Type, Surface Mount)
- Remote E-Stop (Red Mushroom-Type, Flush Mount)
- 100 dB Alarm Horn
- Ground Fault Annunciator
- 120V GFCI and 240V Outlets
- 10A Engine Run Relay

### FUEL TANKS (SIZES ON LAST PAGE)

- 8 in (203.2 mm) Fill Extension
- 13 in (330.2 mm) Fill Extension
- 19 in (482.6 mm) Fill Extension
- Overfill Protection Valve
- 5 Gallon Spill Box Return Hose
- 5 Gallon Spill Box
- Tank Risers
- 90% Fuel Level Switch and Alarm
- 12' Emergency Vent
- Fire Rated Stainless Steel Fuel Hose
- Fuel Drop Tube
- Vent Extensions
- All Tanks Above 52 gal Available in Extended Option

## ENGINEERED OPTIONS

### ENGINE SYSTEM

- Coolant Heater Ball Valves
- Fluid Containment Pan

### GENERATOR SET

- Special Testing

### FUEL TANKS

- UL 2085 Tank
- Stainless Steel Tank
- Special Fuel Tanks

EPA Certified Stationary Emergency

**APPLICATION AND ENGINEERING DATA**

**ENGINE SPECIFICATIONS**

General

Make	Perkins
EPA Emissions Compliance	Stationary Emergency
EPA Emissions Reference	See Emission Data Sheet
Cylinder #	4
Type	In-line
Displacement - in <sup>3</sup> (L)	135 (2.22)
Bore - in (mm)	3.3 (84)
Stroke - in (mm)	3.9 (100)
Compression Ratio	23.3:1
Intake Air Method	Turbocharged/Aftercooled
Cylinder Head	Cast Iron
Piston Type	Aluminum
Crankshaft Type	Forged Steel

Engine Governing

Governor	Electronic Isochronous
Frequency Regulation (Steady State)	±0.5%

Lubrication System

Oil Pump Type	Gear Driven
Oil Filter Type	Full-Flow Cartridge
Crankcase Oil Capacity - qt (L)	11.2 (10.6)

Cooling System

Cooling System Type	Closed Recovery
Fan Type	Pusher
Fan Speed - RPM	1,980
Fan Diameter - in (mm)	18.0 (457.2)

Fuel System

Fuel Type	Ultra Low Sulfur Diesel Fuel
Fuel Specifications	ASTM
Fuel Filtering (Microns)	5
Fuel Inject Pump	Distribution Injection Pump
Fuel Pump Type	Cassette
Injector Type	Indirect
Fuel Supply Line - in (mm)	0.31 (7.94) ID
Fuel Return Line - in (mm)	0.19 (4.76) ID

Engine Electrical System

System Voltage	12 VDC
Battery Charger Alternator	Standard
Battery Size	See Battery Index 0161970SBY
Battery Voltage	12 VDC
Ground Polarity	Negative

**STANDARD ALTERNATOR SPECIFICATIONS**

Standard Model	K0035124Y26
Poles	4
Field Type	Revolving
Insulation Class - Rotor	H
Insulation Class - Stator	H
Total Harmonic Distortion	<5% (3-Phase Only)
Telephone Interference Factor (TIF)	<50

Standard Excitation	Synchronous Brushless
Bearings	Single Sealed
Coupling	Direct via Flexible Disc
Prototype Short Circuit Test	Yes
Voltage Regulator Type	Digital
Number of Sensed Phases	All
Regulation Accuracy (Steady State)	±0.25%

EPA Certified Stationary Emergency

**OPERATING DATA**

**POWER RATINGS**

	Standby	
Single-Phase 120/240 VAC @1.0pf	15 kW	Amps: 63
Three-Phase 120/208 VAC @0.8pf	15 kW	Amps: 52
Three-Phase 120/240 VAC @0.8pf	15 kW	Amps: 45
Three-Phase 277/480 VAC @0.8pf	15 kW	Amps: 23
Three-Phase 346/600 VAC @0.8pf	15 kW	Amps: 18

**MOTOR STARTING CAPABILITIES (SKVA)**

skVA vs. Voltage Dip			
277/480 VAC 3Ø	30%	208/240 VAC 3Ø	35%
K0050124Y26	29	K0050124Y26	44
K0035044N26	29	K0035044N26	44

**FUEL CONSUMPTION RATES\***

Fuel Pump Lift - ft (m)	Diesel - gph (Lph)	
3 (1)	Percent Load	Standby
Total Fuel Pump Flow (Combustion + Return) - gph (Lph)	25%	0.9 (3.4)
	50%	1.0 (3.8)
	75%	1.1 (4.2)
	100%	1.3 (5.0)
	16.6 (63.0)	

\*Fuel supply installation must accommodate fuel consumption rates at 100% load.

**COOLING**

	Standby	
Coolant Flow	gpm (Lpm)	14.9 (56.4)
Coolant System Capacity	gal (L)	3.3 (12.5)
Heat Rejection to Coolant	BTU/hr (kW)	128,638 (37.7)
Inlet Air	cfm (m <sup>3</sup> /min)	3,841 (109)
Maximum Operating Ambient Temperature	°F (°C)	122 (50)
Maximum Operating Ambient Temperature (Before Derate)	See Bulletin No. 0199280SSD	
Maximum Additional Radiator Backpressure	in H <sub>2</sub> O (kPa)	0.5 (0.12)

**COMBUSTION AIR REQUIREMENTS**

	Standby
Flow at Rated Power - scfm (m <sup>3</sup> /min)	87.9 (2.5)

**ENGINE**

	Standby	
Rated Engine Speed	RPM	1,800
Horespower at Rated kW**	hp	24.4
Piston Speed	ft/min (m/ min)	1,182 (360.3)
BMEP	psi (kPa)	79.4 (547.6)

\*\*Refer to "Emissions Data Sheet" for maximum bHP for EPA and SCAQMD permitting purposes.

**EXHAUST**

	Standby	
Exhaust Flow (Rated Output)	scfm (m <sup>3</sup> / min)	158.5 (4.5)
Maximum Allowable Exhaust Backpressure (Post Silencer)	inHg (kPa)	3.1 (10.5)
Exhaust Temperature (Rated Output)	°F (°C)	513.5 (267.5)

Deration – Operational characteristics consider maximum ambient conditions. Derate factors may apply under atypical site conditions. Please contact a Generac Power Systems Industrial Dealer for additional details. All performance ratings in accordance with BS5514 and DIN6271 standards. Standby - See Bulletin 0187500SSB

# SD015T | 2.2L | 15 kW

## INDUSTRIAL DIESEL GENERATOR SET

EPA Certified Stationary Emergency

### DIMENSIONS AND WEIGHTS\*

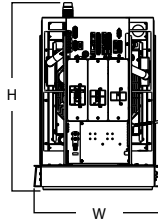
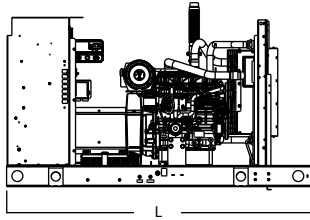

#### OPEN SET

Run Time - Hours	Usable Capacity - gal (L)	L x W x H - in (mm)	Weight - lbs (kg)
No Tank	-	83.6 (2,122) x 35.0 (888) x 46.3 (1,177)	1,291 (586)
40	52 (197)	83.6 (2,122) x 35.0 (888) x 59.7 (1,517)	1,826 (828)
42	55 (208)	96.0 (2,438) x 35.0 (888) x 59.7 (1,517)	1,870 (848)
99	130 (492)	83.6 (2,122) x 35.0 (888) x 72.7 (1,847)	2,093 (949)
144	190 (719)	96.0 (2,438) x 35.0 (888) x 82.3 (2,091)	2,368 (1,074)
180	237 (897)	83.6 (2,122) x 35.0 (888) x 82.3 (2,091)	2,347 (1,064)

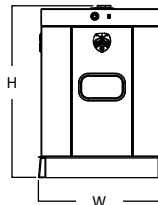
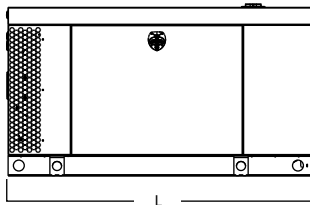

#### LEVEL 0 SOUND ATTENUATED ENCLOSURE

Run Time - Hours	Usable Capacity - gal (L)	L x W x H - in (mm)	Weight - lbs (kg)	
			Steel	Aluminum
No Tank	-	83.6 (2,122) x 35.0 (888) x 47.4 (1,203)	1,476 (669)	1,665 (755)
40	52 (197)	83.6 (2,122) x 35.0 (888) x 60.8 (1,543)	2,011 (912)	2,200 (998)
42	55 (208)	96.0 (2,438) x 35.0 (888) x 60.8 (1,543)	2,055 (932)	2,244 (1,018)
99	130 (492)	83.6 (2,122) x 35.0 (888) x 73.8 (1,874)	2,278 (1,033)	2,467 (1,119)
144	190 (719)	96.0 (2,438) x 35.0 (888) x 83.4 (2,117)	2,553 (1,158)	2,742 (1,244)
180	237 (897)	83.6 (2,122) x 35.0 (888) x 83.4 (2,117)	2,532 (1,148)	2,721 (1,234)

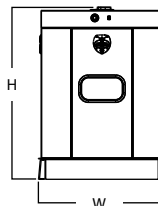
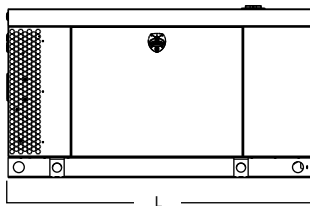

#### LEVEL 1 SOUND ATTENUATED ENCLOSURE

Run Time - Hours	Usable Capacity - gal (L)	L x W x H - in (mm)	Weight - lbs (kg)	
			Steel	Aluminum
No Tank	-	83.6 (2,122) x 35.0 (888) x 47.4 (1,203)	1,480 (671)	1,669 (757)
40	52 (197)	83.6 (2,122) x 35.0 (888) x 60.8 (1,543)	2,015 (914)	2,204 (999)
42	55 (208)	96.0 (2,438) x 35.0 (888) x 60.8 (1,543)	2,059 (934)	2,248 (1,020)
99	130 (492)	83.6 (2,122) x 35.0 (888) x 73.8 (1,874)	2,282 (1,035)	2,471 (1,121)
144	190 (719)	96.0 (2,438) x 35.0 (888) x 83.4 (2,117)	2,557 (1,160)	2,746 (1,245)
180	237 (897)	83.6 (2,122) x 35.0 (888) x 83.4 (2,117)	2,536 (1,150)	2,725 (1,236)

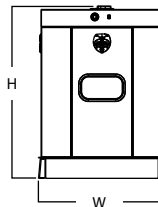
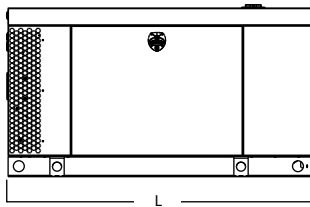

#### LEVEL 2 SOUND ATTENUATED ENCLOSURE

Run Time - Hours	Usable Capacity - gal (L)	L x W x H - in (mm)	Weight - lbs (kg)	
			Steel	Aluminum
No Tank	-	83.6 (2,122) x 35.0 (888) x 47.4 (1,203)	1,481 (672)	1,670 (758)
40	52 (197)	83.6 (2,122) x 35.0 (888) x 60.8 (1,543)	2,016 (914)	2,205 (1,000)
42	55 (208)	96.0 (2,438) x 35.0 (888) x 60.8 (1,543)	2,060 (934)	2,249 (1,020)
99	130 (492)	83.6 (2,122) x 35.0 (888) x 73.8 (1,874)	2,283 (1,036)	2,472 (1,121)
144	190 (719)	96.0 (2,438) x 35.0 (888) x 83.4 (2,117)	2,559 (1,160)	2,748 (1,246)
180	237 (897)	83.6 (2,122) x 35.0 (888) x 83.4 (2,117)	2,537 (1,151)	2,726 (1,236)

\* All measurements are approximate and for estimation purposes only. Specification characteristics may change without notice. Please contact a Generac Power Systems Industrial Dealer for detailed installation drawings. Extended and not extended tank offerings vary. Contact dealer for options.