

STANDBY POWER RATING

400 kW, 500 kVA, 60 Hz

PRIME POWER RATING*

360 kW, 450 kVA, 60 Hz

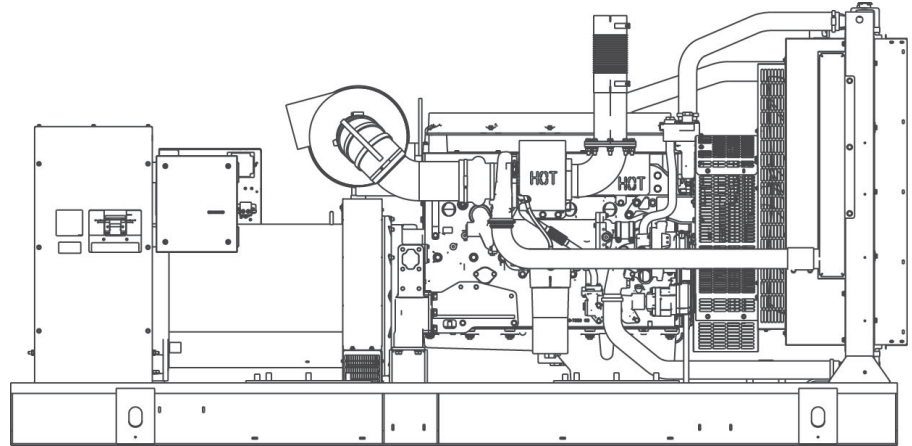

*EPA Certified Prime ratings are not available in the U.S. or its Territories.

Image used for illustration purposes only

CODES AND STANDARDS

Generac products are designed to the following standards:

 UL2200, UL508, UL142, UL498

 NFPA70, 99, 110, 37

 NEC700, 701, 702, 708

 ISO9001, 8528, 3046, 7637,
 Pluses #2b, 4

 NEMA ICS10, MG1, 250, ICS6, AB1

 ANSI C62.41
American National Standards Institute

 IBC 2009, CBC 2010, IBC 2012, ASCE 7-05,
 ASCE 7-10, ICC-ES AC-156 (2012)

POWERING AHEAD

For over 50 years, Generac has led the industry with innovative design and superior manufacturing.

Generac ensures superior quality by designing and manufacturing most of its generator components, including alternators, enclosures and base tanks, control systems and communications software.

Generac's gensets utilize a wide variety of options, configurations and arrangements, allowing us to meet the standby power needs of practically every application.

Generac searched globally to ensure the most reliable engines power our generators. We choose only engines that have already been proven in heavy-duty industrial application under adverse conditions.

Generac is committed to ensuring our customers' service support continues after their generator purchase.

STANDARD FEATURES

ENGINE SYSTEM

General

- Oil Drain Extension
- Air Cleaner
- Fan Guard
- Stainless Steel flexible exhaust connection
- Critical Exhaust Silencer (enclosed only)
- Factory Filled Oil
- Radiator Duct Adapter (open set only)

Fuel System

- Flexible fuel lines
- Primary and secondary fuel filters

Cooling System

- Closed Coolant Recovery System
- UV/Ozone resistant hoses
- Factory-Installed Radiator
- 50/50 Ethylene glycol antifreeze
- 120 VAC Coolant Heater

Engine Electrical System

- Battery charging alternator
- Battery cables
- Battery tray
- Solenoid activated starter motor
- Rubber-booted engine electrical connections

ALTERNATOR SYSTEM

- Class H insulation material
- 2/3 pitch
- Skewed stator
- Permanent Magnet Excitation
- Sealed Bearings
- Amotrisseur winding
- Full load capacity alternator

GENERATOR SET

- Internal Genset Vibration Isolation
- Separation of circuits - high/low voltage
- Separation of circuits - multiple breakers
- Wrapped Exhaust Piping (enclosed only)
- Standard Factory Testing
- 2 Year Limited Warranty (Standby rated Units)
- 1 Year Limited Warranty (Prime rated Units)
- Silencer mounted in the discharge hood (enclosed only)

ENCLOSURE (IF SELECTED)

- Rust-proof fasteners with nylon washers to protect finish
- High performance sound-absorbing material (L1 & L2)
- Gasketed doors
- Stamped air-intake louvers
- Air discharge hoods for radiator-upward pointing
- Stainless steel lift off door hinges
- Stainless steel lockable handles
- Rhino Coat™ - Textured polyester powder coat

TANKS (IF SELECTED)

- UL 142
- Double wall
- Vents
- Sloped top
- Sloped bottom
- Factory pressure tested (2 psi)
- Rupture basin alarm
- Fuel level
- Check valve in supply and return lines
- Rhino Coat™ - Textured polyester powder coat
- Stainless hardware

CONTROL SYSTEM



Control Panel

- Digital H Control Panel - Dual 4x20 Display
- Programmable Crank Limiter
- 7-Day Programmable Exerciser
- Special Applications Programmable PLC
- RS-232/485
- All-Phase Sensing DVR
- Full System Status
- Utility Monitoring
- Low Fuel Pressure Indication
- 2-Wire Start Compatible
- Power Output (kW)

- Power Factor
- kW Hours, Total & Last Run
- Real/Reactive/Apparent Power
- All Phase AC Voltage
- All Phase Currents
- Oil Pressure
- Coolant Temperature
- Coolant Level
- Engine Speed
- Battery Voltage
- Frequency
- Date/Time Fault History (Event Log)
- Isochronous Governor Control
- Waterproof/sealed Connectors
- Audible Alarms and Shutdowns
- Not in Auto (Flashing Light)
- Auto/Off/Manual Switch
- E-Stop (Red Mushroom-Type)
- NFPA110 Level I and II (Programmable)
- Customizable Alarms, Warnings, and Events
- Modbus protocol
- Predictive Maintenance algorithm
- Sealed Boards
- Password parameter adjustment protection

- Single point ground
- 15 channel data logging
- 0.2 msec high speed data logging
- Alarm information automatically comes up on the display

Alarms

- Oil Pressure (Pre-programmable Low Pressure Shutdown)
- Coolant Temperature (Pre-programmed High Temp Shutdown)
- Coolant Level (Pre-programmed Low Level Shutdown)
- Low Fuel Pressure Alarm
- Engine Speed (Pre-programmed Over speed Shutdown)
- Battery Voltage Warning
- Alarms & warnings time and date stamped
- Alarms & warnings for transient and steady state conditions
- Snap shots of key operation parameters during alarms & warnings
- Alarms and warnings spelled out (no alarm codes)

CONFIGURABLE OPTIONS

ENGINE SYSTEM

General

- Oil Heater
- Industrial Exhaust Silencer (open set)

Engine Electrical System

- 10A UL battery charger
- Battery Warmer

ALTERNATOR SYSTEM

- Alternator Upsizing
- Anti-Condensation Heater
- Tropical coating (480/600V non-upsized only)

CIRCUIT BREAKER OPTIONS

- Main Line Circuit Breaker
- 2nd Main Line Circuit Breaker
- Shunt Trip and Auxiliary Contact
- Electronic Trip Breakers

GENERATOR SET

- Gen-Link Communications Software (English Only)
- 8 Position Load Center
- 2 Year Extended Warranty
- 5 Year Warranty
- 5 Year Extended Warranty

ENCLOSURE

- Standard Enclosure
- Level 1 Sound Attenuation
- Level 2 Sound Attenuation
- Steel Enclosure
- Aluminum Enclosure
- 180 MPH Wind Kit
- 12 VDC Enclosure Lighting Kit
- 120 VAC Enclosure Lighting Kit
- AC/DC Enclosure Lighting Kit

TANKS (Size on last page)

- Electrical Fuel Level
- Mechanical Fuel Level
- 183 Gal (693 L) Usable Capacity
- 438 Gal (1659 L) Usable Capacity
- 693 Gal (2624 L) Usable Capacity
- 946 Gal (3518 L) Usable Capacity
- 1325 Gal (5015 L) Usable Capacity
- 8" Fill Extension
- 13" Fill Extension
- 19" Fill Extension

CONTROL SYSTEM

- 21-Light Remote Annunciator
- Remote Relay Panel (8 or 16)
- Oil Temperature Sender with Indication Alarm
- Remote E-Stop (Break Glass-Type, Surface Mount)
- Remote E-Stop (Red Mushroom-Type, Surface Mount)
- Remote E-Stop (Red Mushroom-Type, Flush Mount)
- Remote Communication - Modem
- Remote Communication - Ethernet
- 10A Run Relay
- Ground Fault Indication and Protection Functions

ENGINEERED OPTIONS

ENGINE SYSTEM

- Fluid containment pans

ALTERNATOR SYSTEM

- 3rd Breaker Systems

CONTROL SYSTEM

- Spare inputs (x4) / outputs (x4) - H Panel Only
- Battery Disconnect Switch

GENERATOR SET

- Special Testing
- Battery Box

ENCLOSURE

- Motorized Dampers
- Door switches for intrusion alert
- Enclosure ambient heaters

TANKS

- Overfill Protection Valve
- UL2085 Tank
- ULC S-601 Tank
- Stainless Steel Tank
- Special Fuel Tanks (MIDEQ and FL DEP/DERM, etc.)
- Vent Extensions

RATING DEFINITIONS

Standby - Applicable for a varying emergency load for the duration of a utility power outage with no overload capability.

Prime - Applicable for supplying power to a varying load in lieu of utility for an unlimited amount of running time. A 10% overload capacity is available for 1 out of every 12 hours. The Prime Power option is only available on International applications. Power ratings in accordance with ISO 8528-1, Second Edition

SD400 | 12.5L | 400 kW

INDUSTRIAL DIESEL GENERATOR SET

EPA Certified Stationary Emergency

APPLICATION AND ENGINEERING DATA

ENGINE SPECIFICATIONS

General

Make	Perkins
EPA Emissions Compliance	Stationary Emergency
EPA Emissions Reference	See Emissions Data Sheet
Cylinder #	6
Type	In-Line
Displacement - L (cu In)	12.5 (762.80)
Bore - mm (in)	130 (5.12)
Stroke - mm (in)	157 (6.18)
Compression Ratio	16.3:1
Intake Air Method	Turbocharged/Aftercooled
Cylinder Head Type	4 Valve
Piston Type	Aluminum
Crankshaft Type	Drop Forged Steel

Engine Governing

Governor	Electronic Isochronous
Frequency Regulation (Steady State)	+/- 0.25%

Lubrication System

Oil Pump Type	Gear
Oil Filter Type	Full Flow
Crankcase Capacity - L (qts)	38 (40.15)

Cooling System

Cooling System Type	Closed Recovery
Water Pump	Pre-Lubed, Self Sealing
Fan Type	Pusher
Fan Speed (rpm)	1656
Fan Diameter mm (in)	927 (36.5)
Coolant Heater Standard Wattage	1500
Coolant Heater Standard Voltage	120 V

Fuel System

Fuel Type	Ultra Low Sulfur Diesel #2
Fuel Specifications	ASTM
Fuel Filtering (microns)	Primary 10 - Secondary 2
Fuel Injection	Electronic
Fuel Pump Type	Engine Driven Gear
Injector Type	MEUI
Engine Type	Pre-Combustion
Fuel Supply Line mm (in)	12.7 (0.5) NPT
Fuel Return Line mm (in)	12.7 (0.5) NPT

Engine Electrical System

System Voltage	24 VDC
Battery Charging Alternator	Std
Battery Size	See Battery Index 0161970SBY
Battery Group	8D
Battery Voltage	(2) - 12 VDC
Ground Polarity	Negative

ALTERNATOR SPECIFICATIONS

Standard Model	520
Poles	4
Field Type	Revolving
Insulation Class - Rotor	H
Insulation Class - Stator	H
Total Harmonic Distortion	<5%
Telephone Interference Factor (TIF)	<50

Standard Excitation	Permanent Magnet
Bearings	Single Sealed Cartridge
Coupling	Direct, Flexible Disc
Load Capacity - Standby	100%
Prototype Short Circuit Test	Yes
Voltage Regulator Type	Digital
Number of Sensed Phases	All
Regulation Accuracy (Steady State)	± 0.25%

SD400 | 12.5L | 400 kW

INDUSTRIAL DIESEL GENERATOR SET

EPA Certified Stationary Emergency



OPERATING DATA

POWER RATINGS

		Standby
Three-Phase 120/208 VAC @0.8pf	400 kW	Amps: 1389
Three-Phase 120/240 VAC @0.8pf	400 kW	Amps: 1204
Three-Phase 277/480 VAC @0.8pf	400 kW	Amps: 602
Three-Phase 346/600 VAC @0.8pf	400 kW	Amps: 481

STARTING CAPABILITIES (sKVA)

		sKVA vs. Voltage Dip											
		480 VAC						208/240 VAC					
Alternator	kW	10%	15%	20%	25%	30%	35%	10%	15%	20%	25%	30%	35%
Standard	400	387	581	775	968	1162	1356	345	570	835	1100	1450	1710
Upsize 1	555	457	686	914	1143	1371	1600	-	-	-	-	-	-
Upsize 2	642	471	707	943	1179	1414	1650	543	814	1086	1357	1629	1900

FUEL CONSUMPTION RATES*

		Diesel - gal/hr (l/hr)	
Fuel Pump Lift - ft (m)		Percent Load	gph (l/hr)
12 (3.7)		25%	9.8 (37.1)
		50%	16.7 (63.2)
Total Fuel Pump Flow (Combustion + Return) - gal/hr (l/hr)		75%	23.1 (87.4)
159 (600)		100%	27.8 (105.4)

* Fuel supply installation must accommodate fuel consumption rates at 100% load.

COOLING

		STANDBY
Coolant Flow per Minute	gal/min (l/min)	106.2 (402)
Coolant System Capacity	gal (L)	13 (49.2)
Heat Rejection to Coolant	BTU/hr	1,067,520
Inlet Air	cfm (m³/min)	18,685 (529.1)
Max. Operating Radiator Air Temp	°F (°C)	122 (50)
Maximum Additional Radiator Backpressure	in H ₂ O	0.5

COMBUSTION AIR REQUIREMENTS

		STANDBY
Flow at Rated Power	cfm (m³/min)	1180 (33.41)

ENGINE

		STANDBY
Rated Engine Speed	rpm	1800
Horsepower at Rated kW**	hp	578
Piston Speed	ft/min	1854
BMEP	psi	334

EXHAUST

		STANDBY
Exhaust Flow (Rated Output)	cfm (m³/min)	3044 (86.2)
Max. Backpressure (Post Silencer)	inHg (Kpa)	1.5 (5.1)
Exhaust Temp (Rated Output - post silencer)	°F (°C)	1256 (680)
Exhaust Outlet Size (Open Set)	mm (in)	127 (5.0)

** Refer to "Emissions Data Sheet" for maximum bHP for EPA and SCAQMD permitting purposes.

Deration – Operational characteristics consider maximum ambient conditions. Derate factors may apply under atypical site conditions. Please consult a Generac Power Systems Industrial Dealer for additional details. All performance ratings in accordance with ISO3046, BS5514, ISO8528 and DIN6271 standards.

SD400 | 12.5L | 400 kW

INDUSTRIAL DIESEL GENERATOR SET

EPA Certified Stationary Emergency

DIMENSIONS AND WEIGHTS*

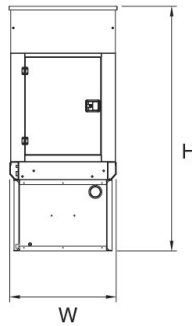
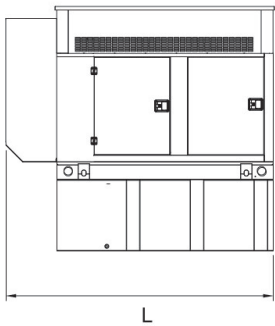
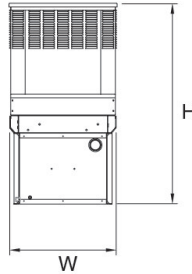
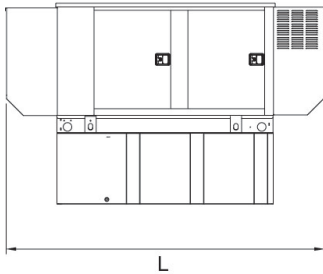
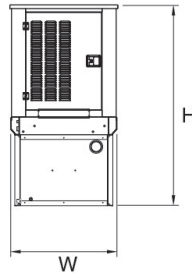
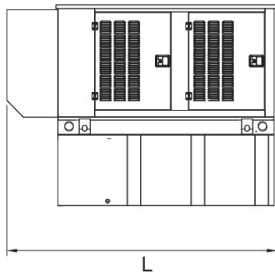
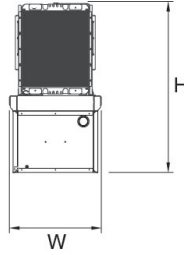
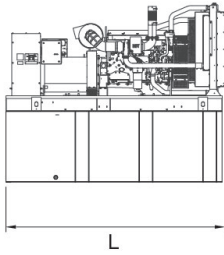

OPEN SET

RUN TIME HOURS	USABLE CAPACITY GAL (L)	L x W x H in (mm)	WT lbs (kg) - Tank & Open Set
NO TANK	-	137.5 (3493) x 57.6 (1463) x 68 (1721)	6649 (3016)
6	183 (693)	137.5 (3493) x 57.6 (1463) x 81 (2051)	7597 (3446)
16	438 (1659)	137.5 (3493) x 57.6 (1463) x 93 (2356)	7909 (3587)
25	693 (2624)	137.5 (3493) x 57.6 (1463) x 105 (2661)	8212 (3725)
34	946 (3518)	208 (5283) x 57.6 (1463) x 109 (2769)	9674 (4388)
48	1325 (5015)	278 (7061) x 57.6 (1463) x 109 (2769)	10689 (4848)

STANDARD ENCLOSURE

RUN TIME HOURS	USABLE CAPACITY GAL (L)	L x W x H in (mm)	WT lbs (kg) - Enclosure Only	
			Steel	Aluminum
NO TANK	-	174.7 (4437) x 57.6 (1463) x 77.8 (1976)	1174 (533)	401 (182)
6	183 (693)	174.7 (4437) x 57.6 (1463) x 91 (2311)		
16	438 (1659)	174.7 (4437) x 57.6 (1463) x 103 (2616)		
25	693 (2624)	174.7 (4437) x 57.6 (1463) x 115 (2921)		
34	946 (3518)	208 (5283) x 57.6 (1463) x 118 (2997)		
48	1325 (5015)	278 (7061) x 57.6 (1463) x 118 (2997)		

LEVEL 1 ACOUSTIC ENCLOSURE

RUN TIME HOURS	USABLE CAPACITY GAL (L)	L x W x H in (mm)	WT lbs (kg) - Enclosure Only	
			Steel	Aluminum
NO TANK	-	200 (5085) x 57.5 (1460) x 77.8 (1976)	2529 (1147)	864 (392)
6	183 (693)	200 (5085) x 57.6 (1463) x 91 (2311)		
16	438 (1659)	200 (5085) x 57.6 (1463) x 103 (2616)		
25	693 (2624)	200 (5085) x 57.6 (1463) x 115 (2921)		
34	946 (3518)	234 (5944) x 57.6 (1463) x 118 (2997)		
48	1325 (5015)	304 (7722) x 57.6 (1463) x 118 (2997)		

LEVEL 2 ACOUSTIC ENCLOSURE

RUN TIME HOURS	USABLE CAPACITY GAL (L)	L x W x H in (mm)	WT lbs (kg) - Enclosure Only	
			Steel	Aluminum
NO TANK	-	180.6 (4588) x 57.6 (1463) x 107.2 (2724)	3132 (1420)	1070 (485)
6	183 (693)	180.6 (4588) x 57.6 (1463) x 120 (3048)		
16	438 (1659)	180.6 (4588) x 57.6 (1463) x 132 (3353)		
25	693 (2624)	180.6 (4588) x 57.6 (1463) x 144 (3658)		
34	946 (3518)	208 (5283) x 57.6 (1463) x 147 (3734)		
48	1325 (5015)	278 (7061) x 57.6 (1463) x 147 (3734)		

YOUR FACTORY RECOGNIZED GENERAC INDUSTRIAL DEALER

*All measurements are approximate and for estimation purposes only. Sound dBA can be found on the sound data sheet. Enclosure Only weight is added to Tank & Open Set weight to determine total weight.

Specification characteristics may change without notice. Dimensions and weights are for preliminary purposes only. Please consult a Generac Power Systems Industrial Dealer for detailed installation drawings.